

Wireless Charging Tray
241321-51-1 | Power: 5W



WIRELESS CHARGING

Audi A4 B6 (8E) 11/2000 - 2006*
Audi A4 B7 (8E) 04/2002 - 03/2008*

* Nur für Fahrzeuge mit Single-DIN
* Only for vehicles with 1-DIN head unit

D

EINBAUANLEITUNG

Schwierigkeitsgrad

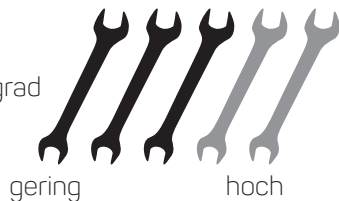

gering

hoch

GB

INSTALLATION GUIDE

level of difficulty



low

high

Audi A4 Limousine B6 (Typ 8E) 11/2000 - 2004*
Audi A4 Avant B6 (Typ 8E) 09/2001 - 11/2004*
Audi A4 Cabriolet B6 (Typ 8E) 04/2002 - 2006*
Audi A4 Limousine B7 (Typ 8E) 11/2004 - 09/2007*
Audi A4 Avant B7 (Typ 8E) 11/2004 - 03/2008*
Audi A4 Cabriolet B7 (Typ 8E) 01/2006 - 02/2009*

* Nur für Fahrzeuge mit Single-DIN
* Only for vehicles with 1-DIN head unit

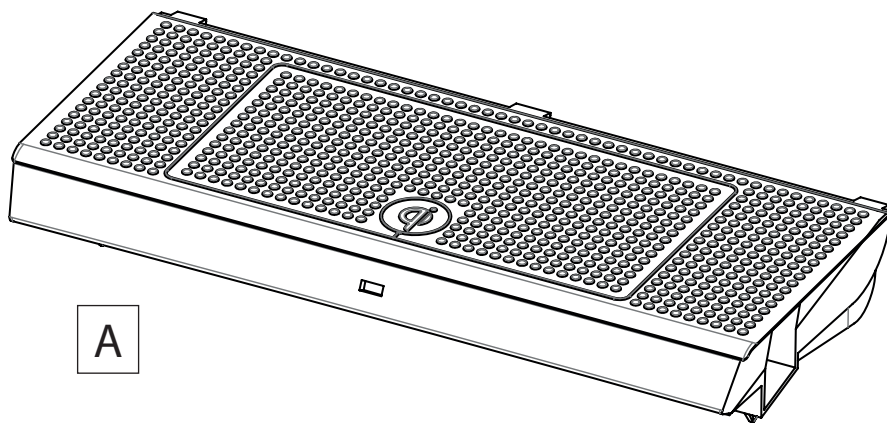

A

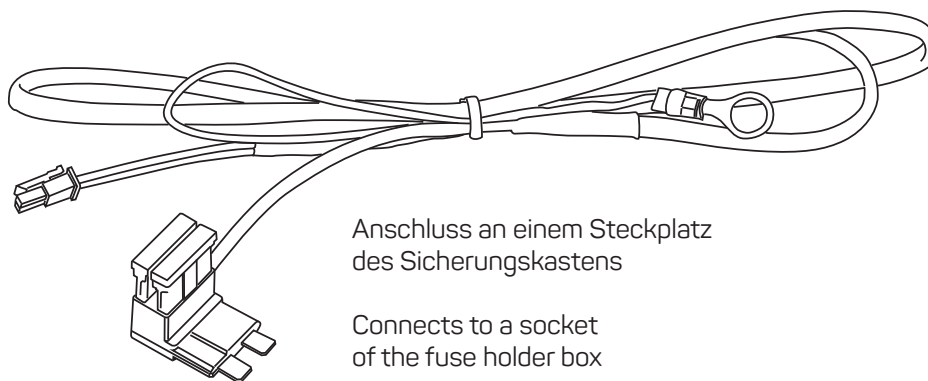

Anschluss an einem Steckplatz
des Sicherungskastens

Connects to a socket
of the fuse holder box

B

Sachgemäße Installation unter Beachtung dieser Einbauanleitung erforderlich. Achten Sie auf korrekte Anschlüsse. Verlegen Sie die Kabel so, dass Sie weder geknickt, gequetscht oder beschädigt werden können. Sorgen Sie dafür, dass sich die Kabel nicht in Gegenständen verfangen können.

Wir können keine Haftung für Schäden übernehmen, welche durch unsachgemäße Installation oder Nutzung verursacht wurden. Verwenden Sie darum ausschließlich das mitgelieferte Montagematerial.

Technische Änderungen vorbehalten, alle Angaben ohne Gewähr.

Das „Qi“ Logo ist Warenzeichen des „Wireless Power Consortium“

An appropriate installation in observance of these operating instructions is necessary. Please make sure the wiring is arranged so it is not bended or crimped due to the risk of cable break. Make sure that all connections are correct. Route the cable away from moving parts, do not allow the cable to be entangled, pinched or damaged in any way.

We will not be liable for damage due to improper installation or utilization. Use the specified accessory parts to prevent product failure.

Subject to technical modifications; no responsibility is accepted for the accuracy of this information.

The “Qi” symbol is a trademark of the “Wireless Power Consortium”



2x 8 mm 



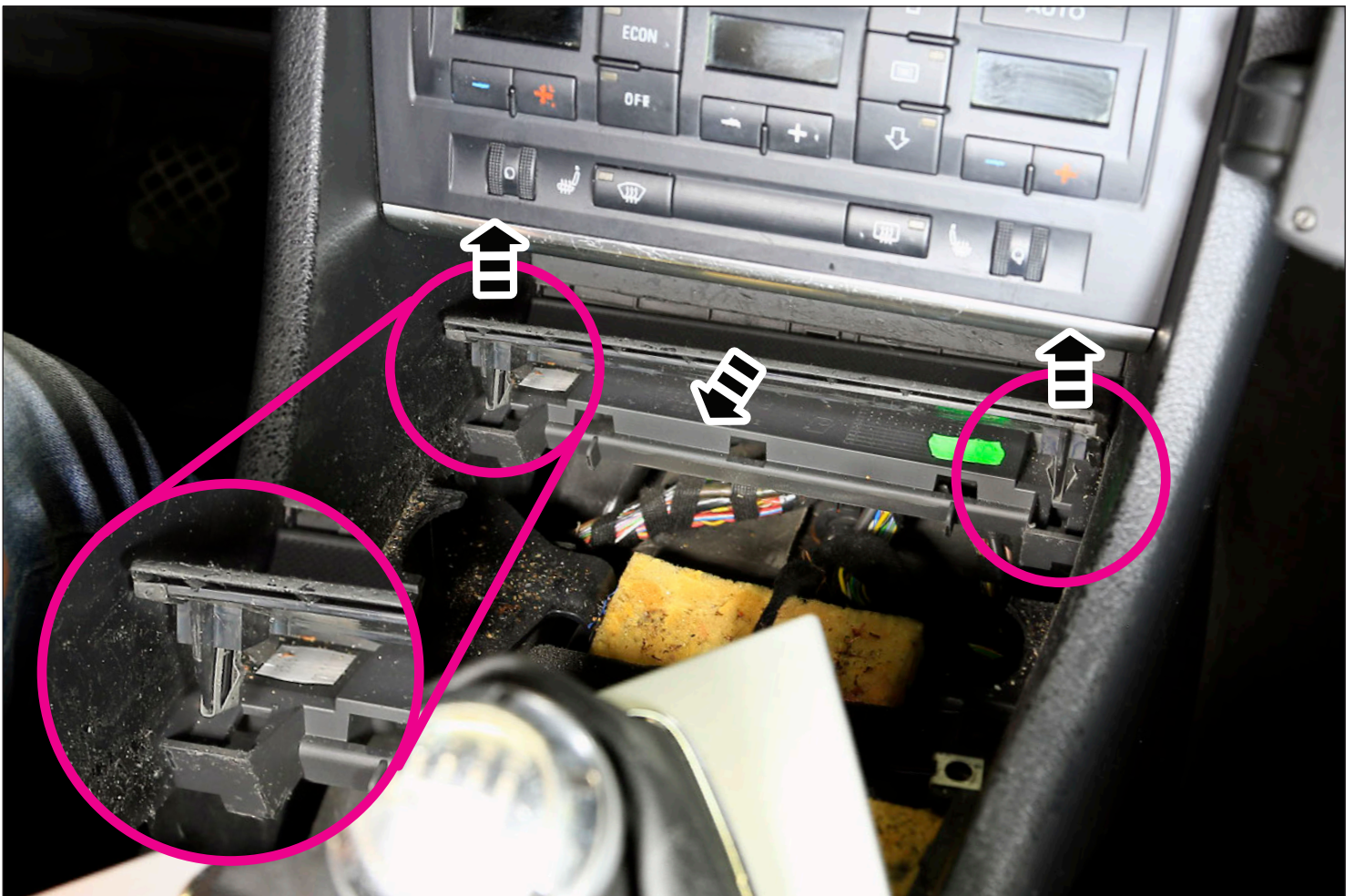

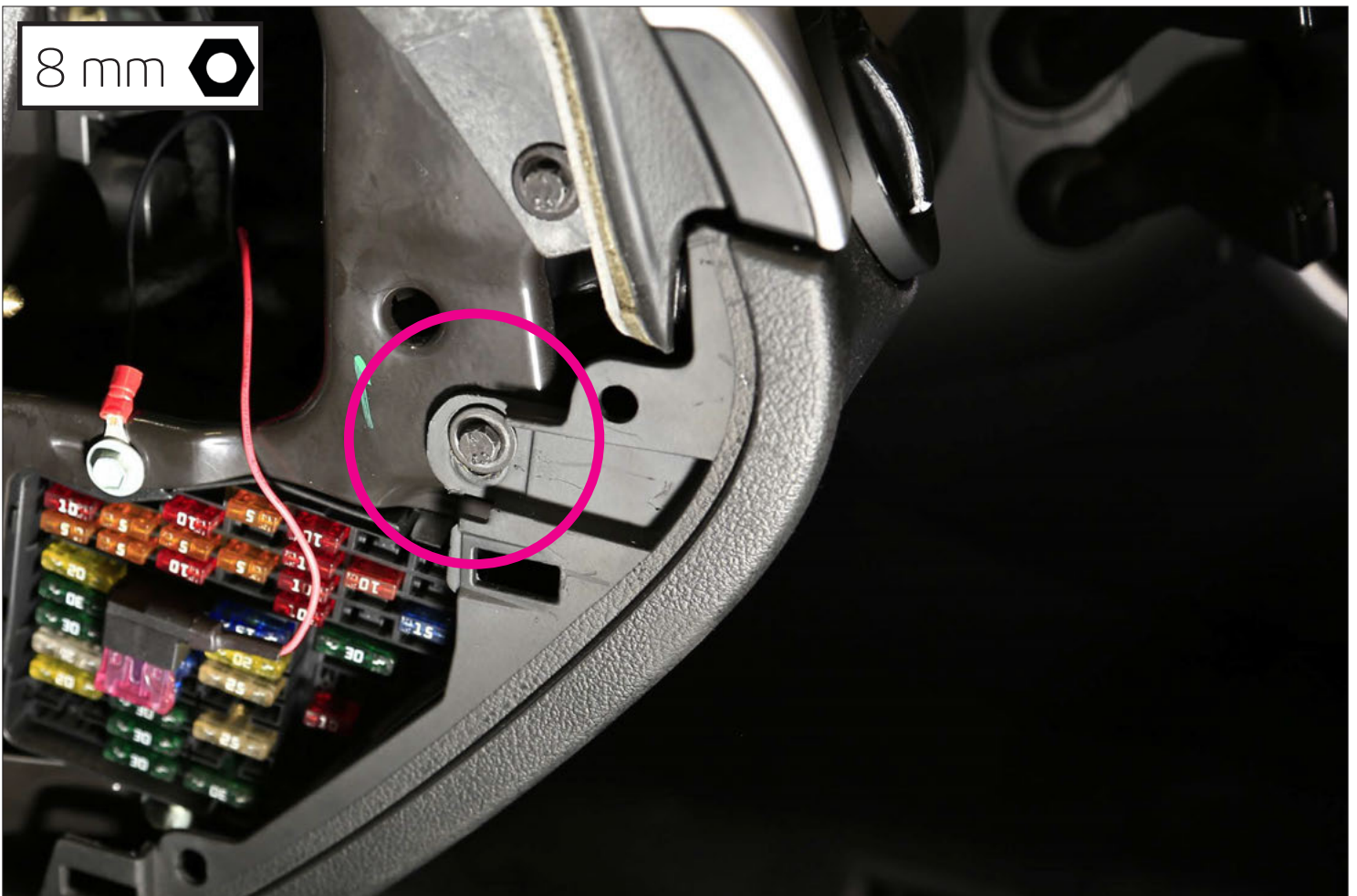

8 mm 



8 mm 



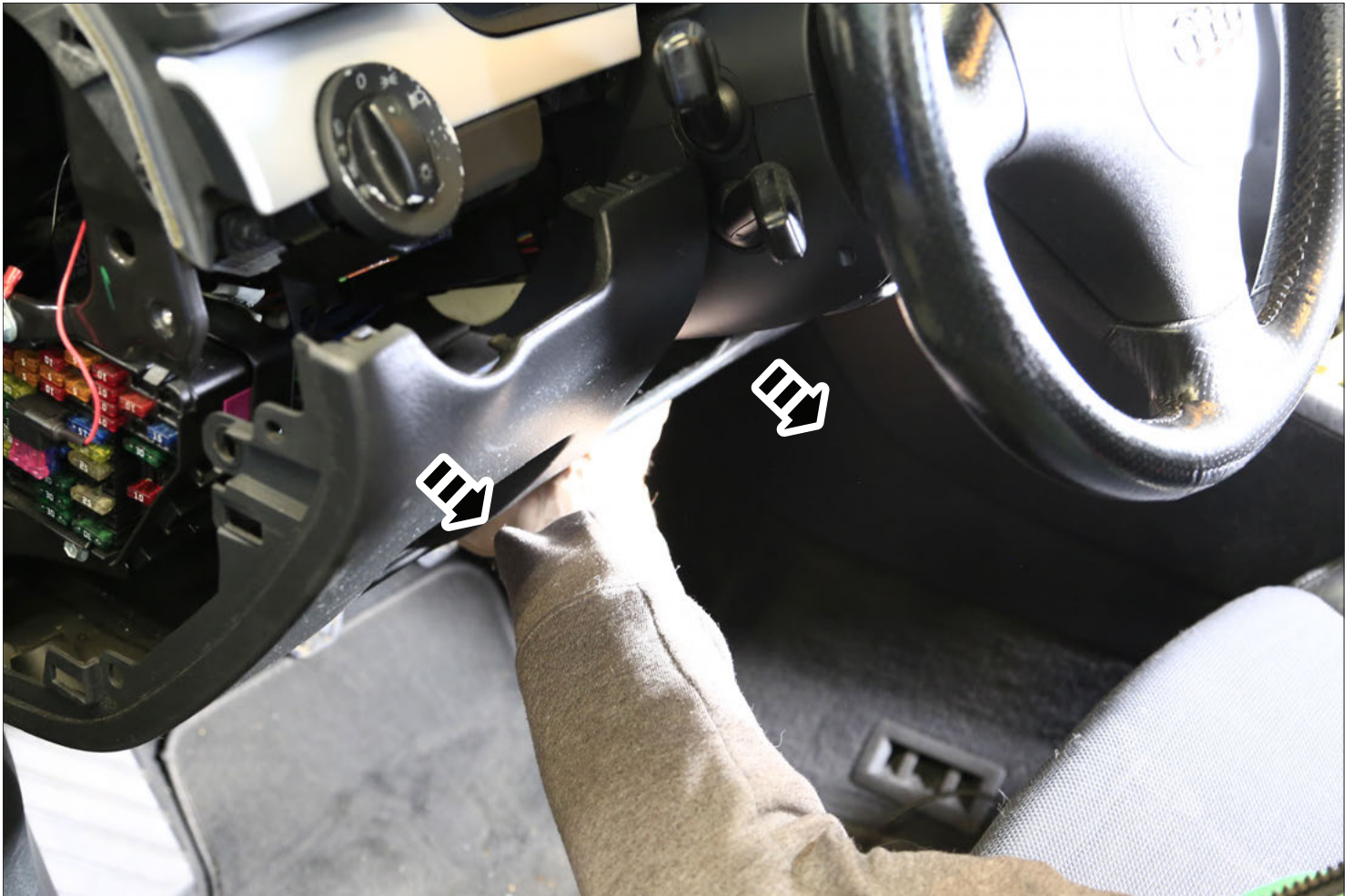

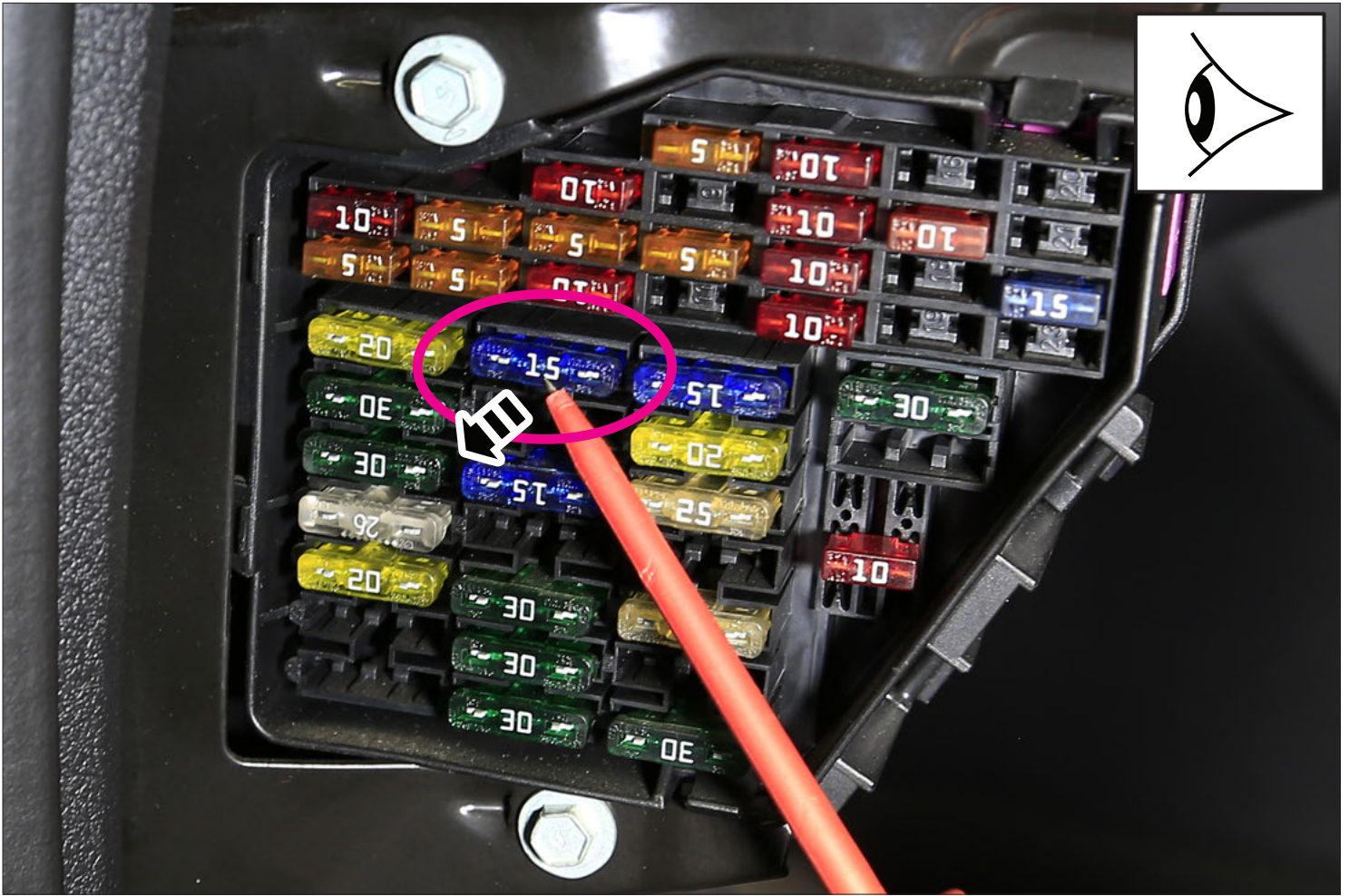

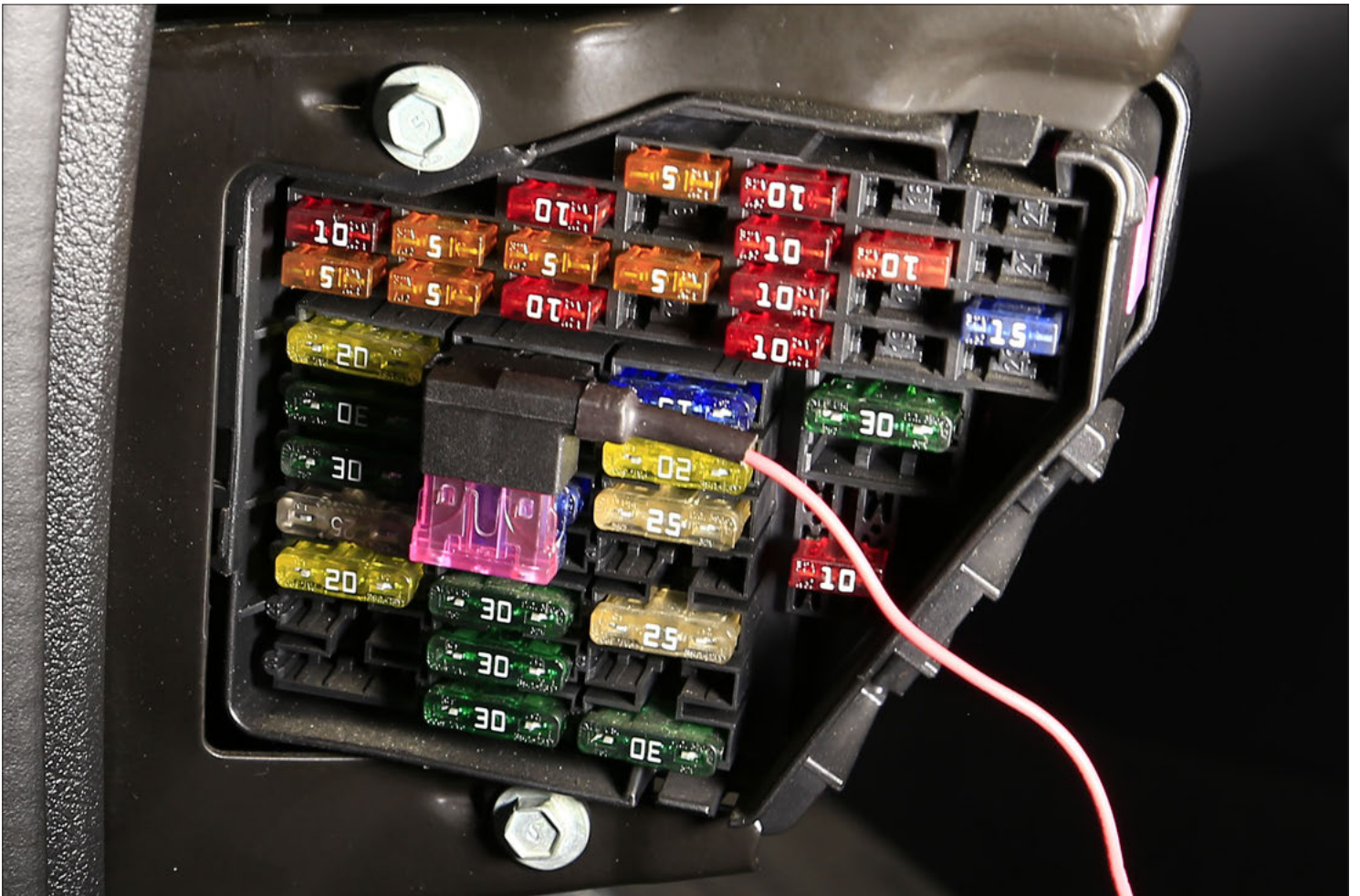
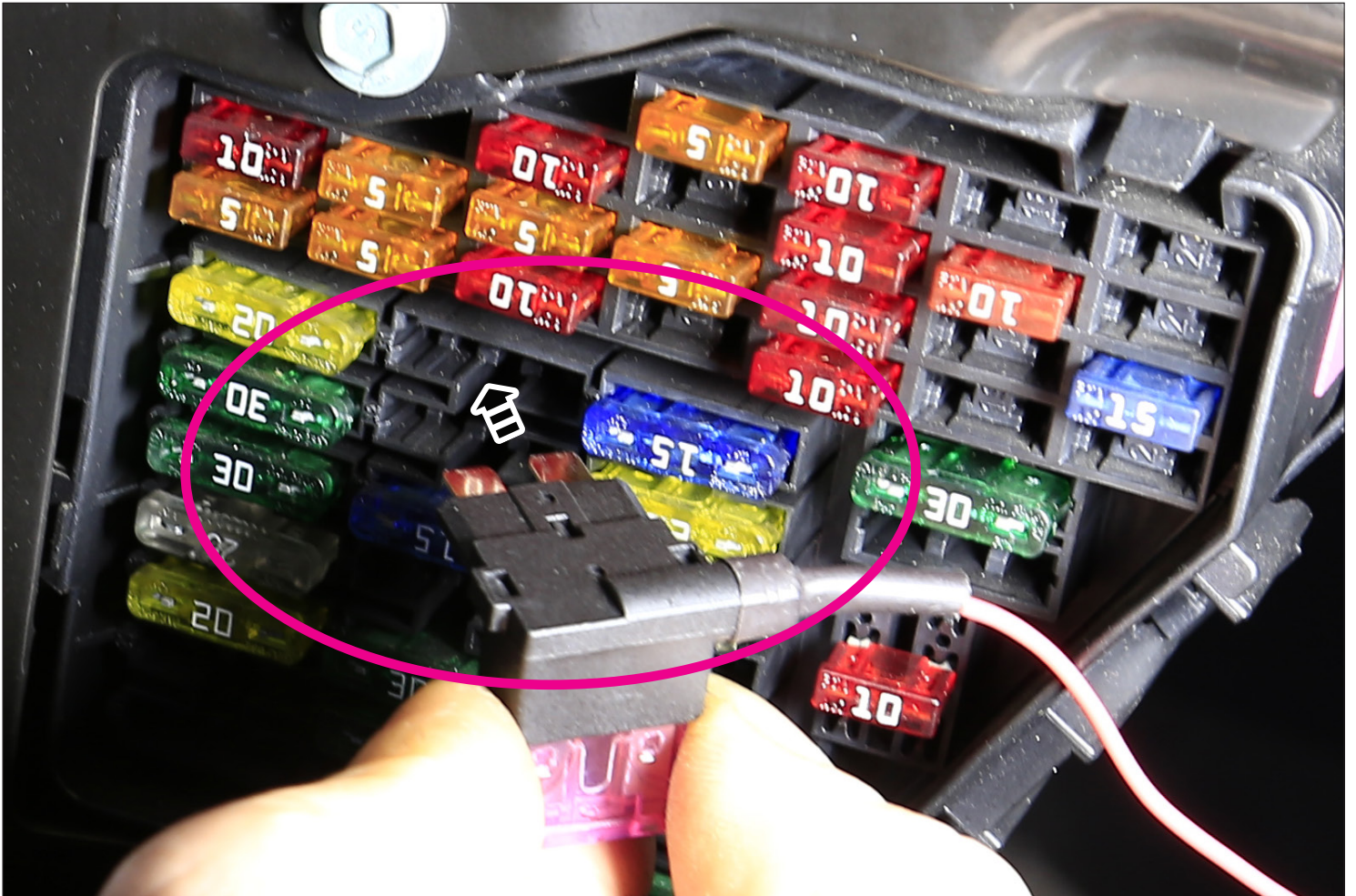

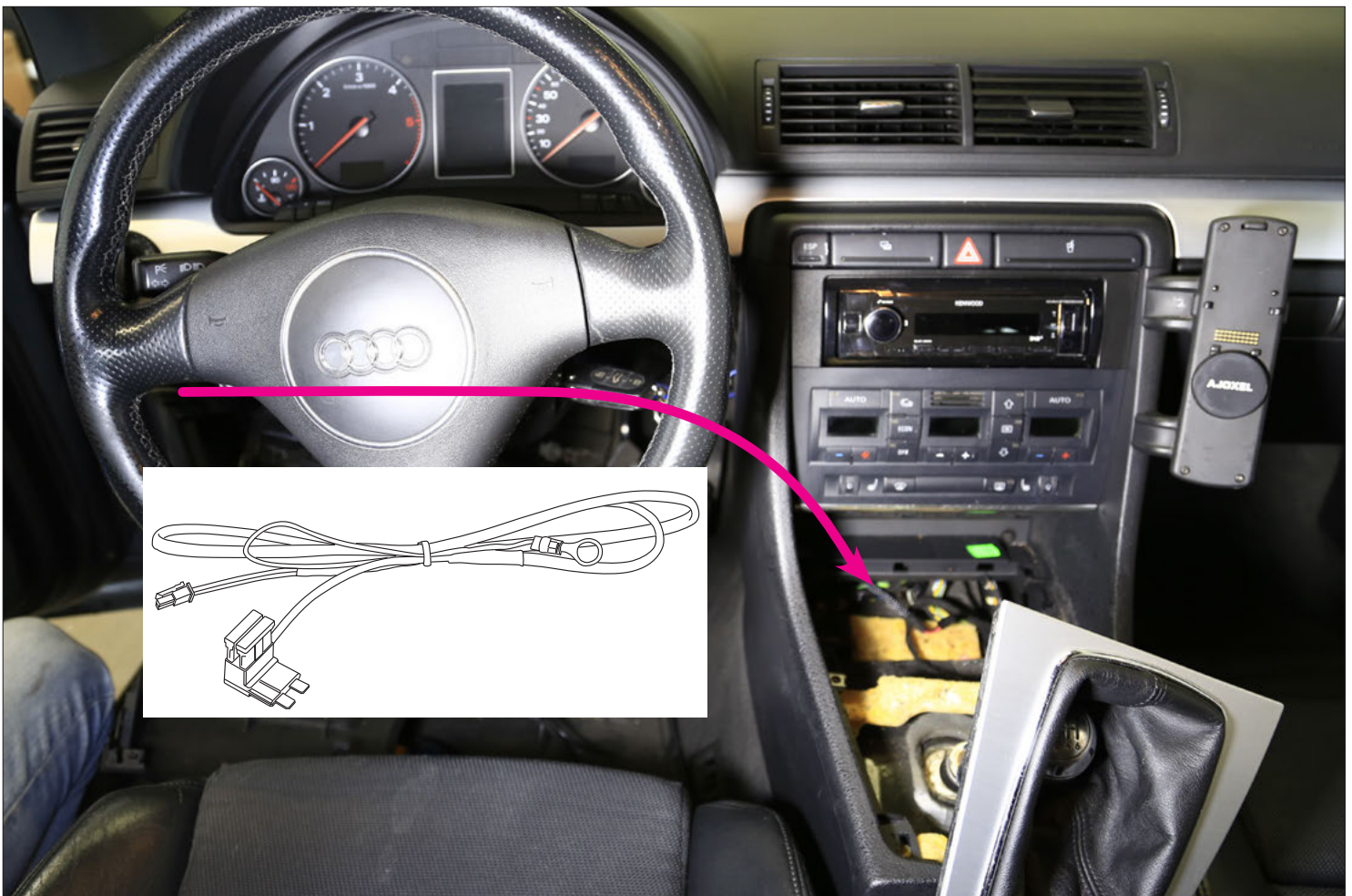
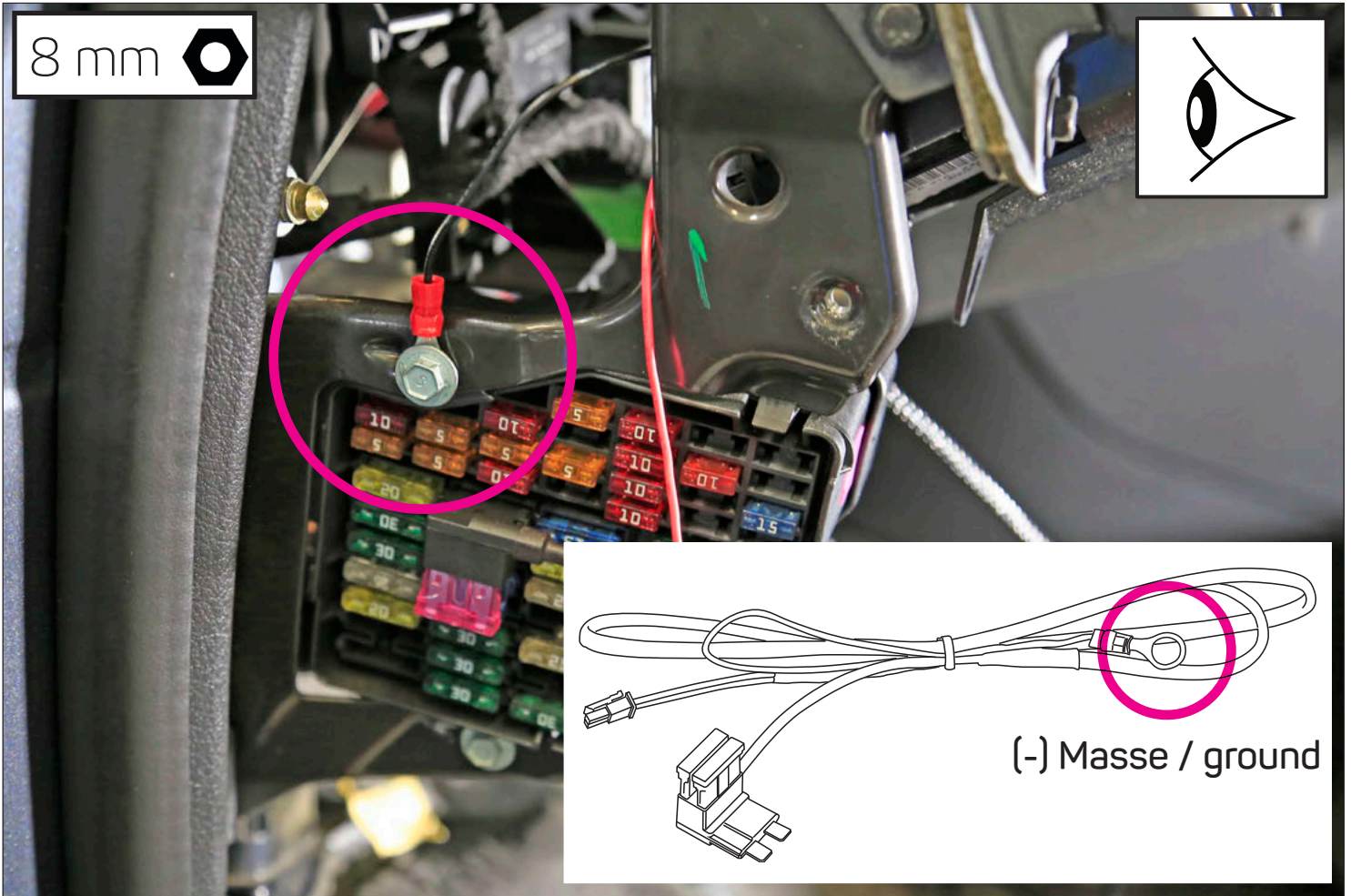

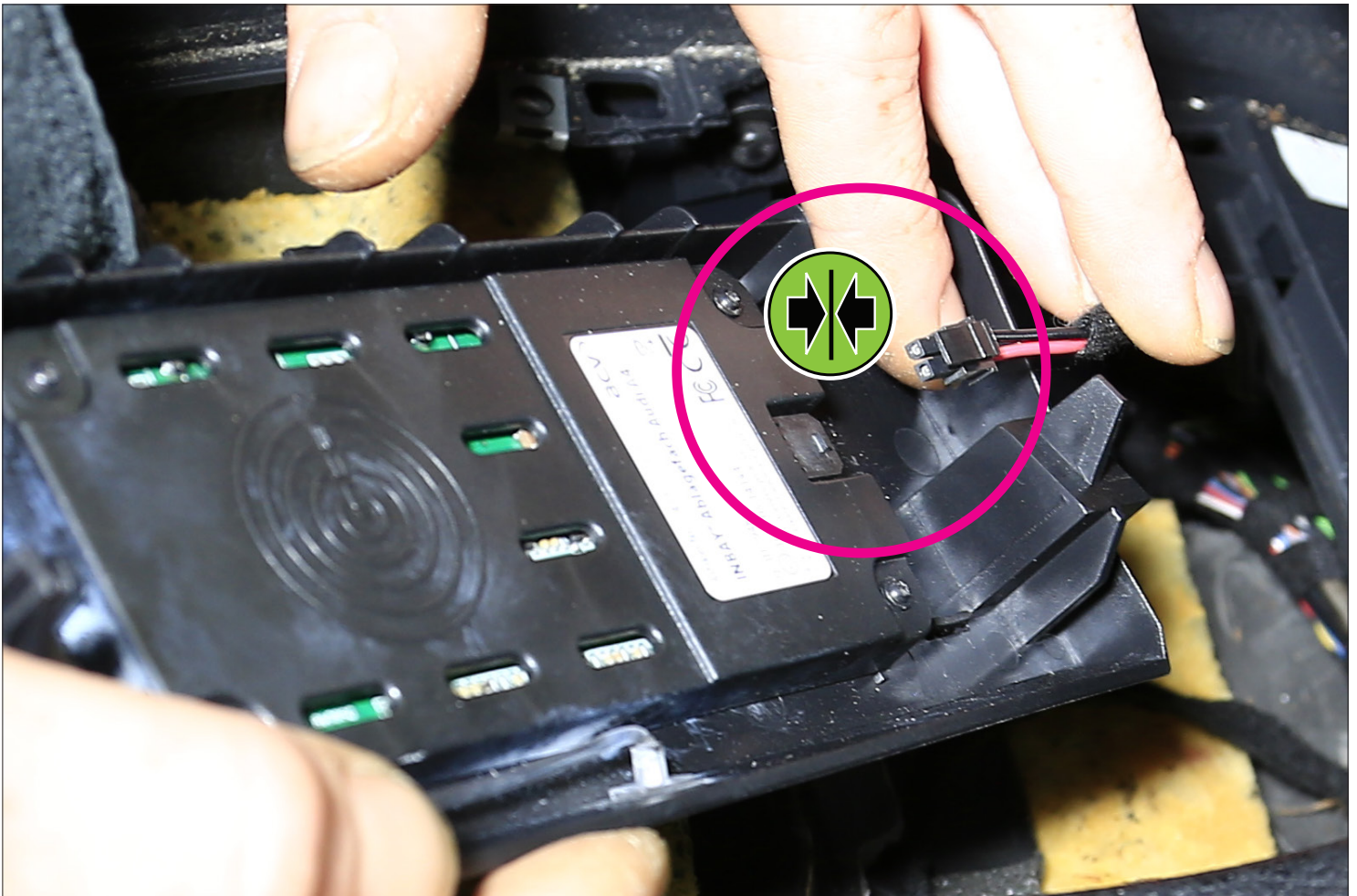
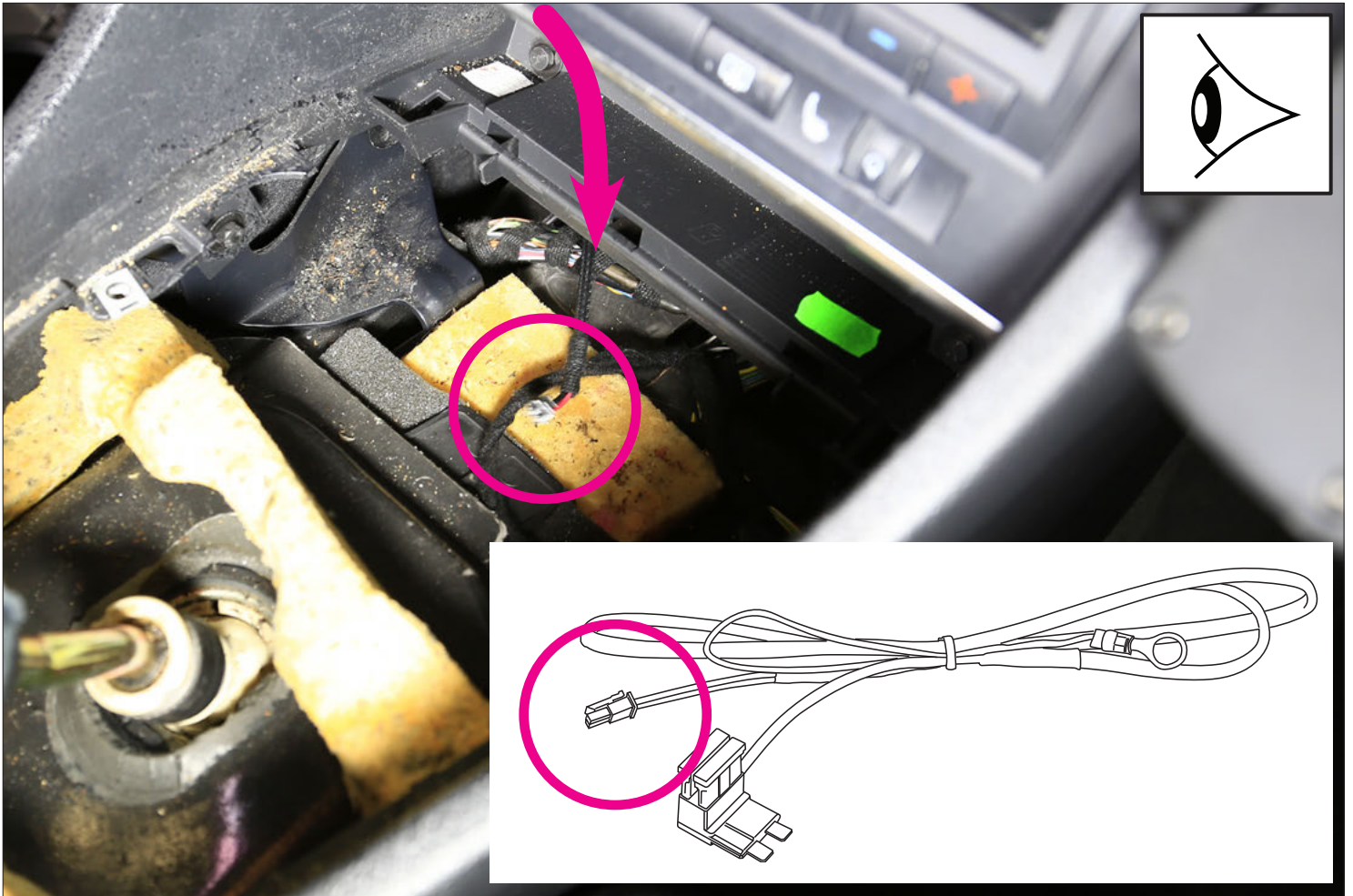

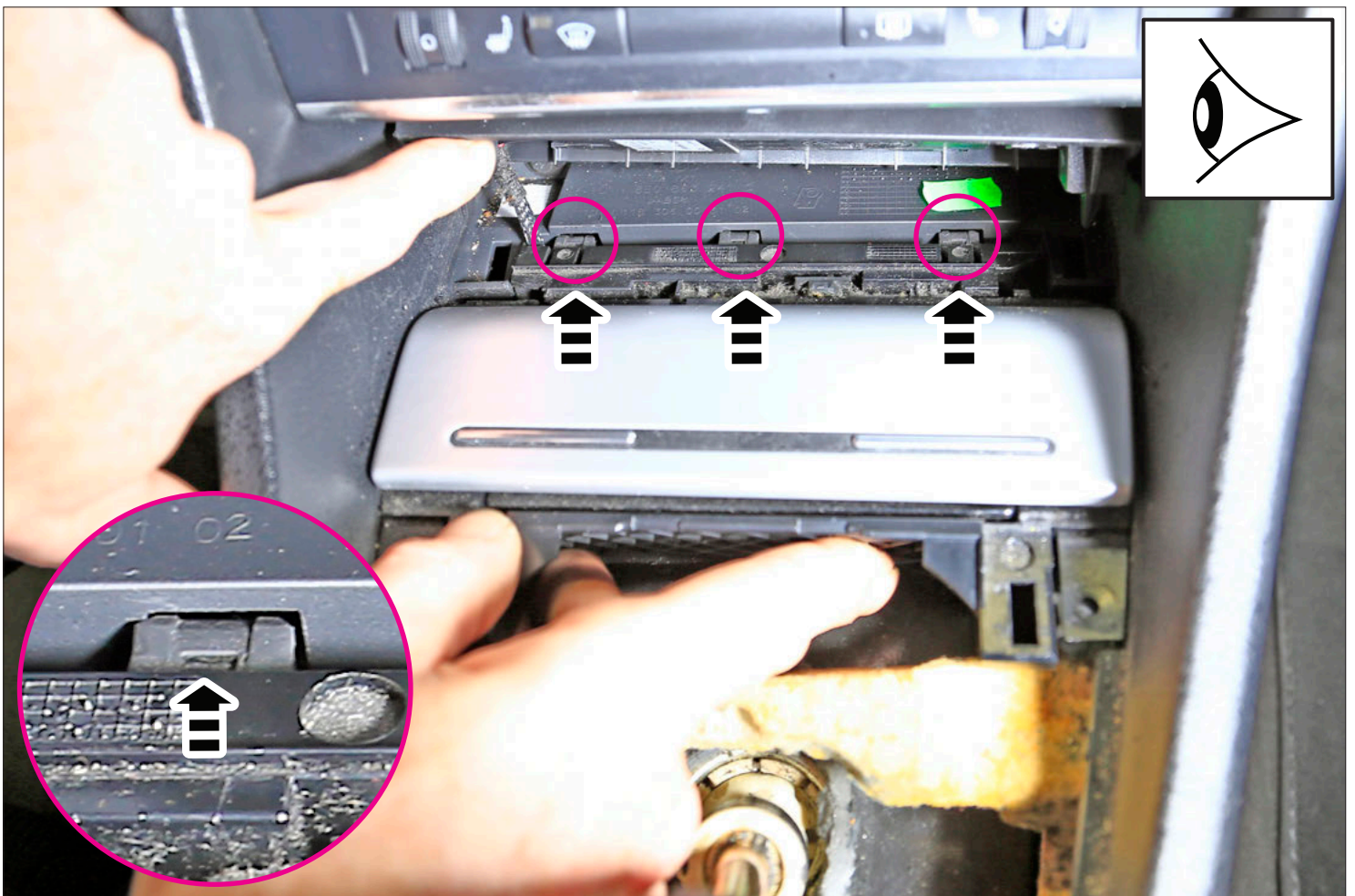
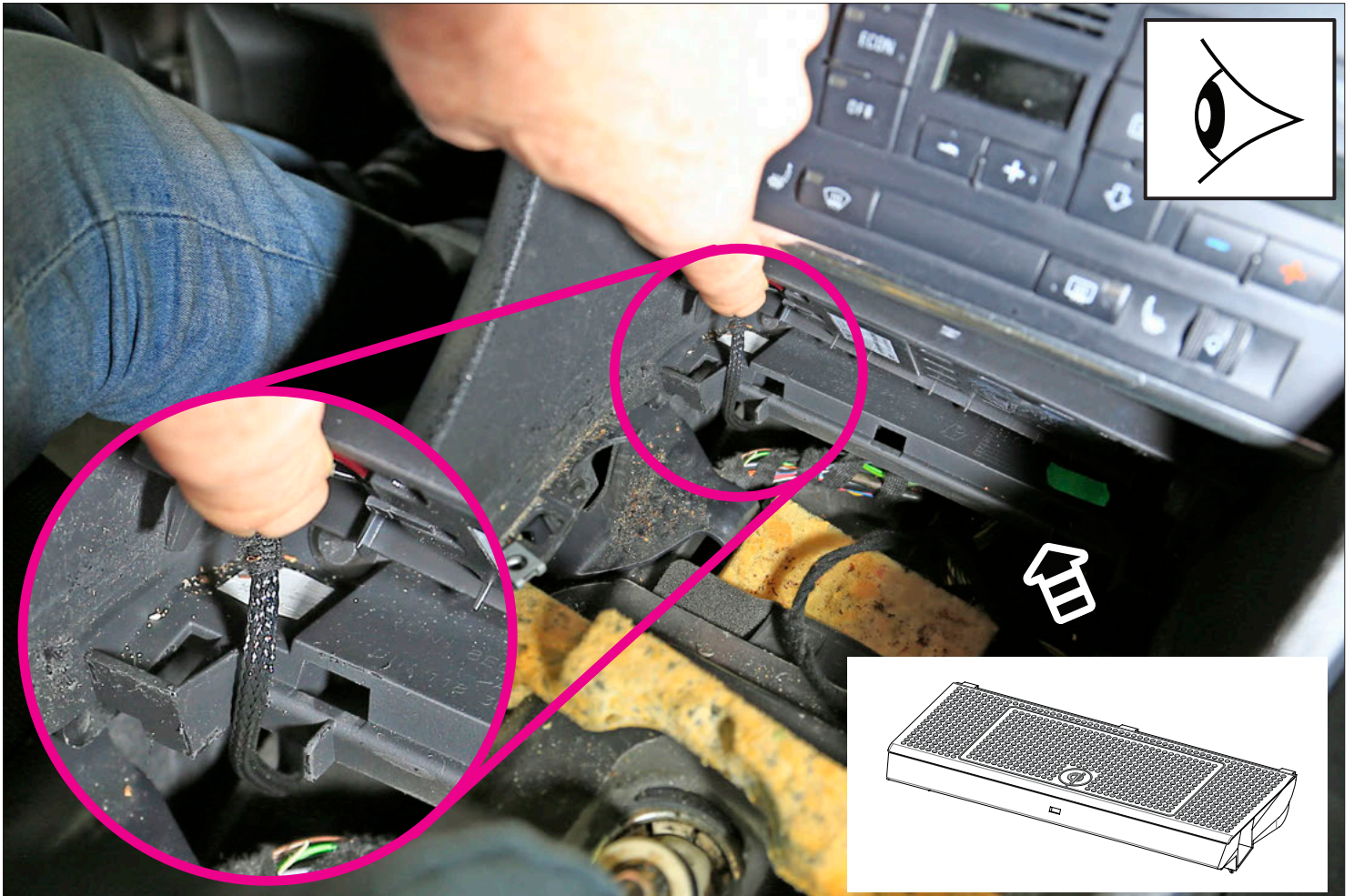

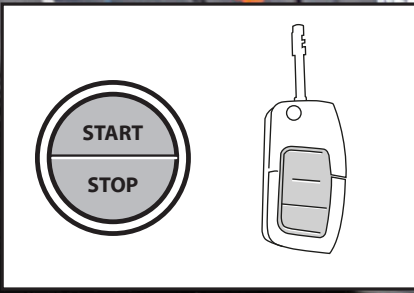

Rote LED
Red LED



standby

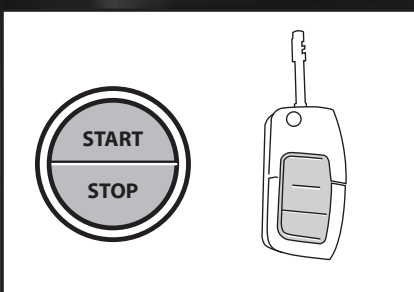

Blaue LED
Blue LED



INTEGRATED FOREIGN OBJECT DETECTION (FOD)



WICHTIGE INFORMATION:

Bitte legen Sie keine anderen Gegenstände wie z.B. Münzen, Kreditkarten etc. in die INBAY Ablage. **Insbesondere Smartphones mit angebrachtem Ring Ständer dürfen nicht verwendet werden** - da ansonsten aus Sicherheitsgründen der Ladevorgang durch die integrierte Fremdeilerkennung (FOD) gestoppt wird.

IMPORTANT INFORMATION:

Please don't place any other objects such as coins, credit cards etc. onto the INBAY surface. **Especially smartphones with attached ring stand holder must not be used!** - otherwise the integrated Foreign Object Detection (FOD) will interrupt wireless charging for safety reasons.

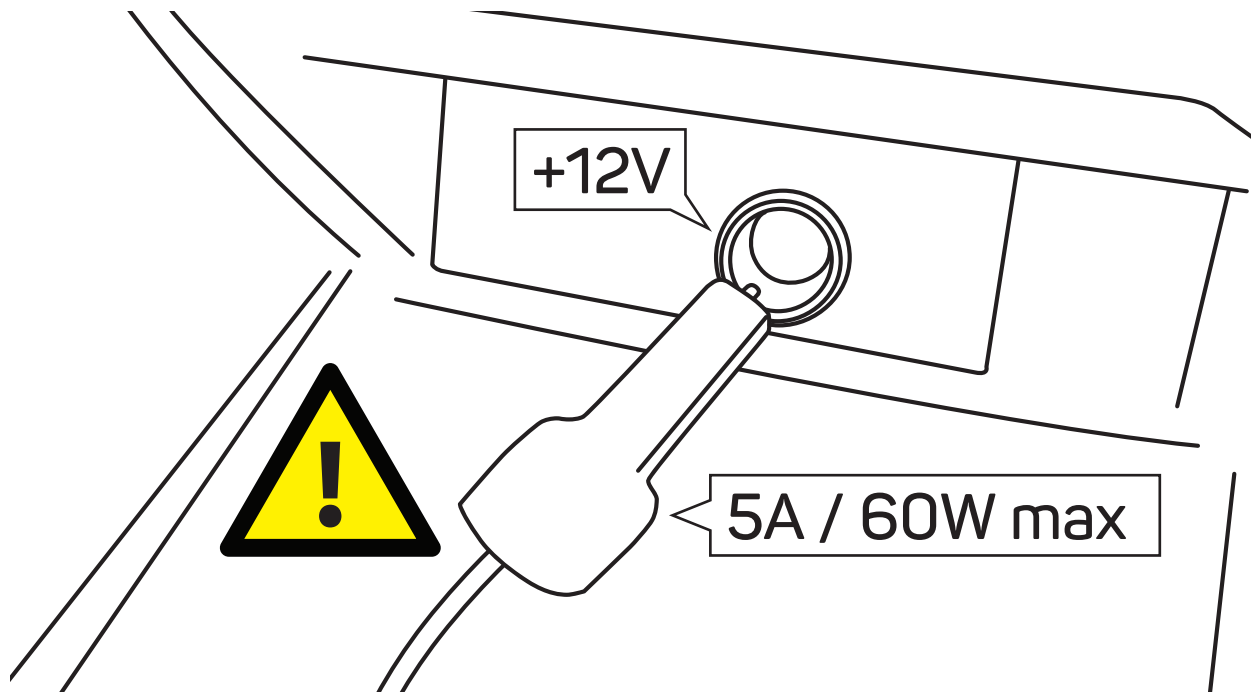
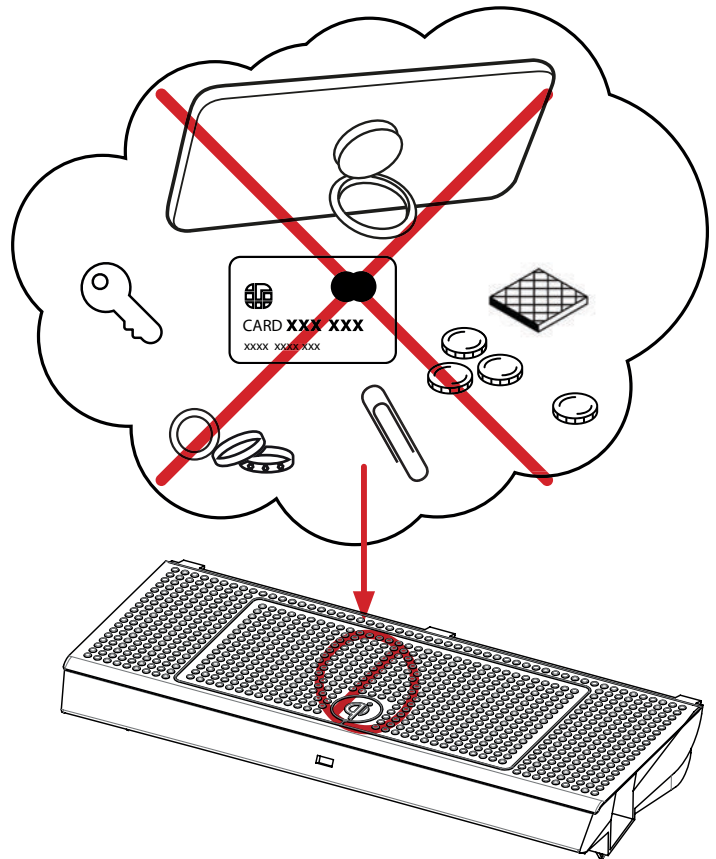

ACHTUNG! Nach der Installation dürfen keine Geräte/Verbraucher mit mehr als **5A / 60W** an der +12V Buchse betrieben werden, da sonst die Gefahr einer Überspannung besteht!

ATTENTION! After installation, devices/consumers with more than **5A / 60W** shall not be operated on the +12V socket. Otherwise a risk of overvoltage can occur!

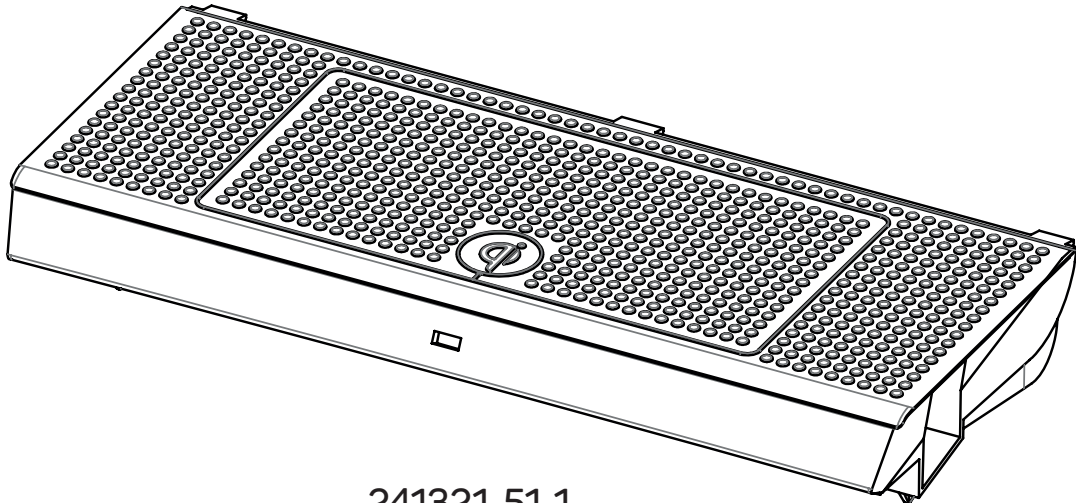

241321-51-1

Input Voltage	12V (DC)
Output Voltage	5V
Output Current	1.1A
Output Power	5W

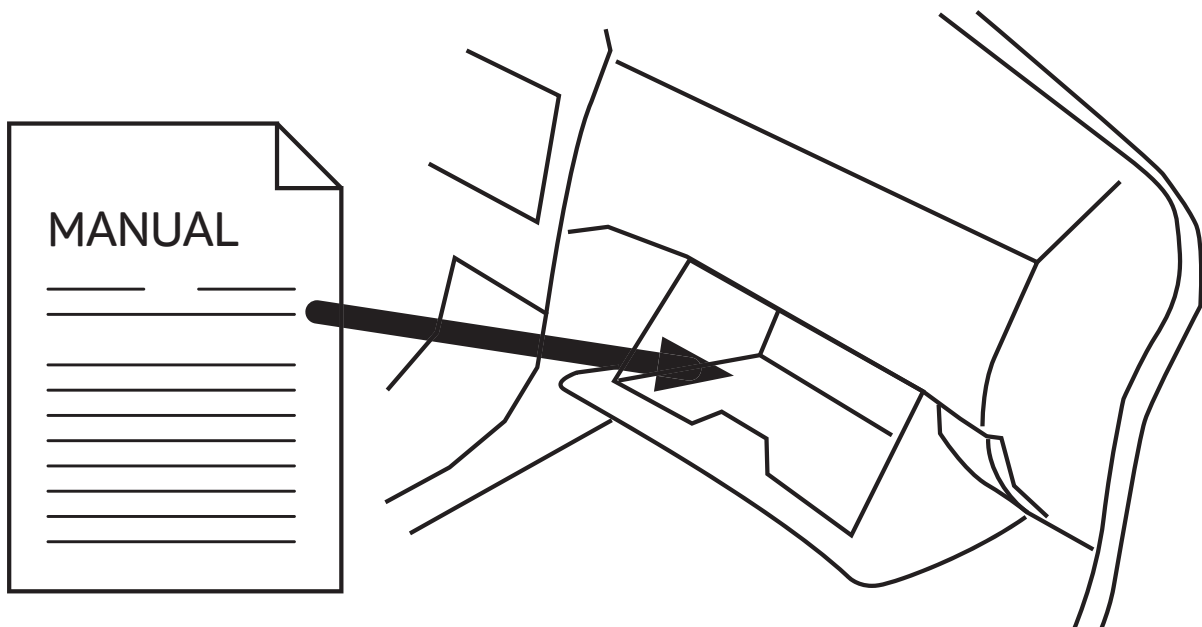

WICHTIG! NACH DER INSTALLATION MUSS DIESE EINBAUANLEITUNG IN DAS HANDSCHUHFACH DES KUNDENFAHRZEUGS GELEGT WERDEN.

IMPORTANT! AFTER INSTALLATION THE MANUAL HAS TO BE PLACED INTO THE DASH BOARD OF THE CUSTOMER'S CAR.

