



CTUFT02 FIAT INFODAPTER



INSTRUCTION MANUAL

www.connects2.com

Designed and
Engineered
in the UK. 

ABOUT

The Connects2 Infodapter for Fiat 500X 2015> vehicles allows vehicle setting and parking sensor information to be displayed on any aftermarket head unit with rear camera input. The Infodapter also allows the use of the steering wheel controls with almost every steering wheel control compatible head unit on the market.

DIP SWITCH SETTINGS

See Fig 1.

Up = Off, Down = On

1: On = Pioneer head units. Off = All other head units

2: Setting for reverse camera. On = PAL, Off = NTSC. The default setting is Off (NTSC).

3: Resets the display settings back to default. If the display settings have been manipulated in a way that it is no longer possible to make adjustments, change the DIP switch #3 from Off to On and back. This will reset the screen settings to the factory defaults. During this procedure the screen background will change to red. While the background is red, no settings can be made.

4: Not applicable

Interface Connections

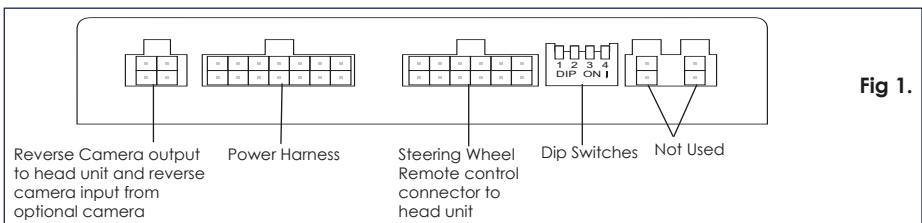

Fig 1.

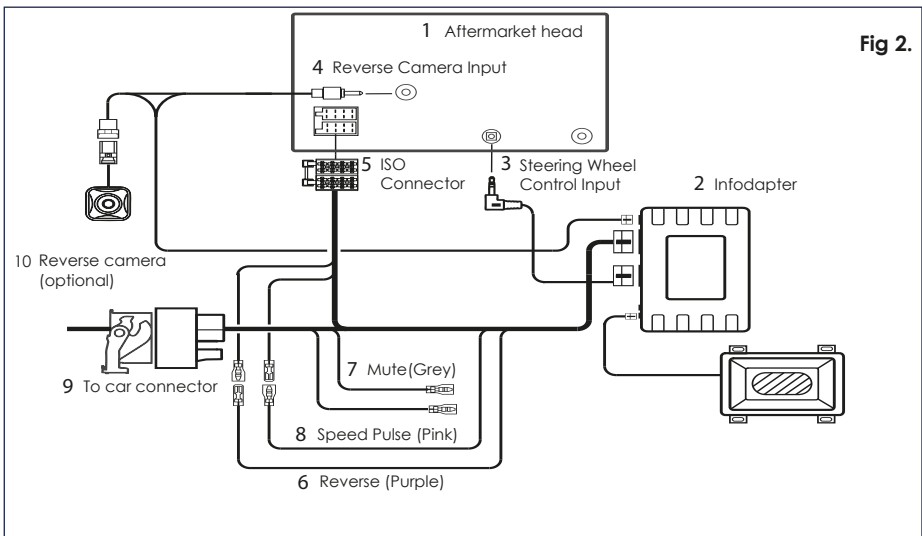

Fig 2.

Steering Wheel Controls

1 Speech Button

2 Track Up/Down



Fig 3.

Configuration Menu

To access the menu, **push and hold the speech button** for 2 seconds (Fig. 3). (if no speech button, pick up can be used) This will enable the configuration menu. To navigate through the menu options use the **Track Up/ Track Down buttons**. To select a menu

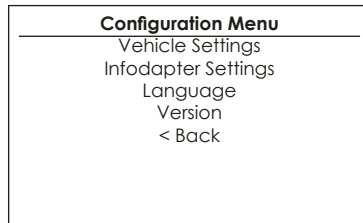

- Vehicle Settings**
 Vehicle settings can be adjusted via the menu. All vehicle setup options that were available with the original head unit, are now available through the aftermarket head unit. See the vehicle handbook for more information regarding these features.

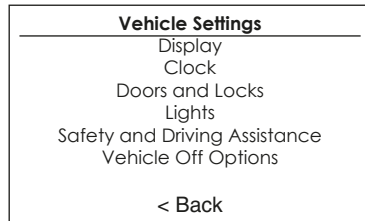

- Infodapter Settings**
 - Screen Size/Position -
 Make sure all 4 corner markers are touching the corners of the aftermarket head unit display.

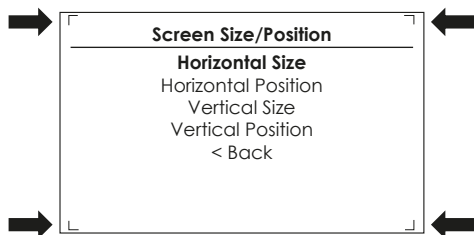

Configuration Menu...continued

- Picture Settings - Adjust Brightness, contrast and colour saturation.

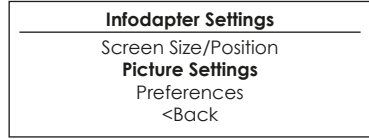

- Preferences -

Park Assist Version - Select according to the colour configuration of the park assist fitted to the vehicle.

Camera Connected - Select Yes if an optional camera is connected.

Reverse Priority* - Select which image (Camera or Park Assist) will be shown by default when reversing. The driver can select the desired image by pushing the Source button (Fig.3) while reversing. (*Note this option is only available when Camera Connected is set to Yes)

Park Brake Source - Set to Speed, Brake or Always On.

Restore factory settings - Reverts all Infodapter settings to factory defaults. (This does not restore vehicle settings)

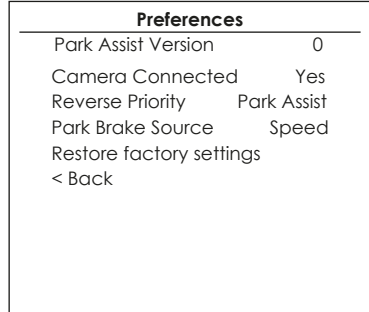

Legal Information

Please consult the relevant road traffic laws governing the country in which this product is being operated. No liability is accepted for material damage, loss or personal injury, directly or indirectly, from installation and operation of this product. This product should only be operated when safe to do so.