

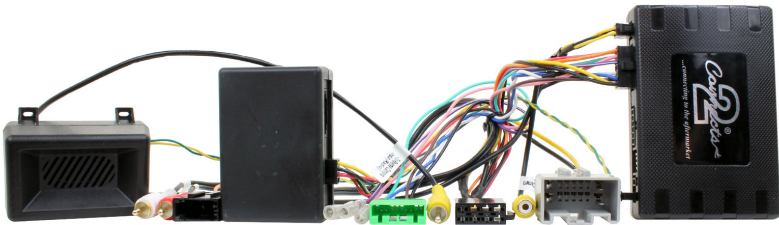

CTULR04 LAND ROVER INFODAPTER



INSTRUCTION MANUAL

www.connects2.com

Designed and
Engineered
in the UK. 

ABOUT

The Connects2 Infodapter for Land Rover vehicles provides retention of the vehicle's OEM steering wheel controls, amplifier, visual park aid and time/date change.

Land Rover Freelander (II) 2006 - 2014

DIP SWITCH SETTINGS

See Fig 1.

Up = Off, Down = On

1: On = Pioneer Head Units. Off = All Other Head Units

2: Setting for reverse camera. On = PAL, Off = NTSC. The default setting is Off (NTSC).

3: Resets the display settings back to default. If the display settings have been manipulated in a way that it is no longer possible to make adjustments, change the DIP switch #3 from Off to On and back. This will reset the screen settings to the factory defaults. During this procedure the screen background will change to red. While the background is red, no settings can be made.

4: Not applicable

Interface Connections

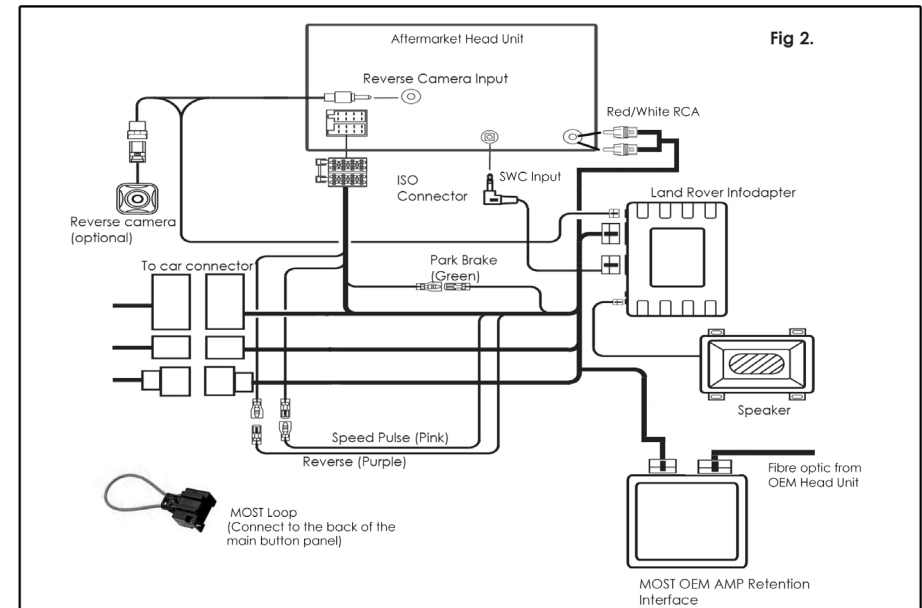
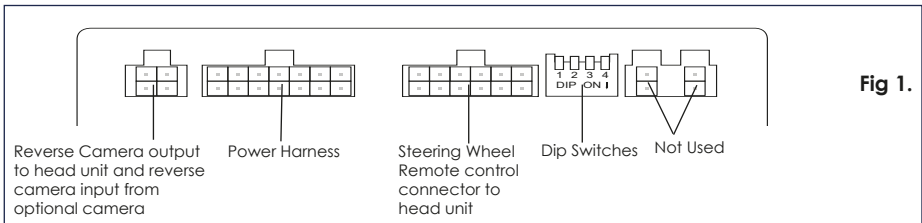

Steering Wheel Controls

1. Mode
2. Track Up/Down
3. Volume +/-
4. Pick Up/Hang Up

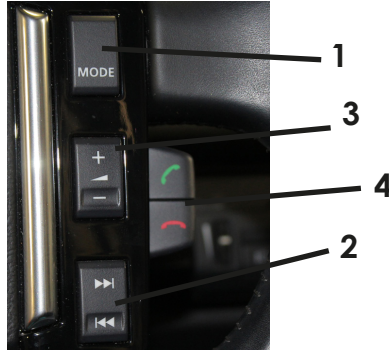
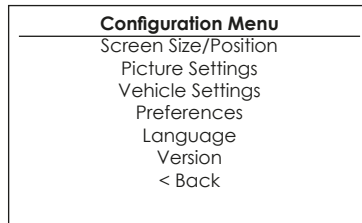

Fig 3.

Configuration Menu

To access the menu, **push and hold the Mode button** for 2 seconds (Fig. 3).(if no speech button, pick up can be used) This will enable the configuration menu. To navigate through the menu options use the **Track Up/ Track Down buttons**. To select a menu option, push the **Mode button once**.



- o Screen Size/Position - Make sure all 4 corner markers are touching the corners of the aftermarket head unit display.

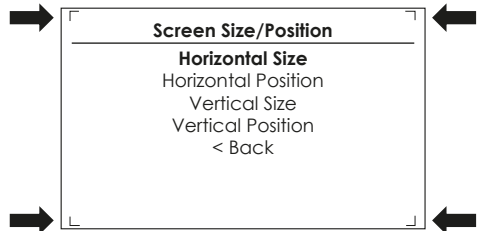

Configuration Menu...continued

- o Picture Settings -
Adjust Brightness, contrast and
colour saturation.

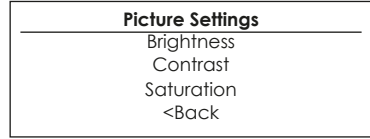

- o Time/Date -
Adjust the vehicle's Time/Date
settings

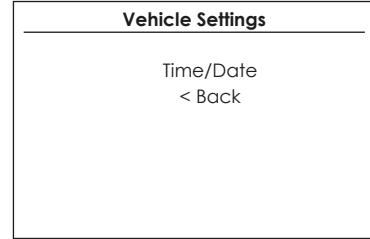

- o Preferences -

Driver Position - Select Left or Right depending upon vehicle configuration.

Park Brake Source - Set to Speed, Brake or Always On.

Restore factory settings - Reverts all Infodapter settings to factory defaults. (This does not restore vehicle settings)

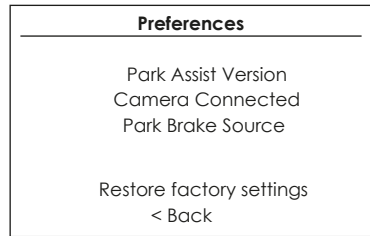

Legal Information

Please consult the relevant road traffic laws governing the country in which this product is being operated. No liability is accepted for material damage, loss or personal injury, directly or indirectly, from installation and operation of this product. This product should only be operated when safe to do so.